

GR (A.G.-O.G.)

GR-Cast Resin (L.V.-M.V.)

نظام قناة بسبار الرانتيجي



ASTA



KEMA

VNL
EKT



CE



ISO 9001-14001-18001

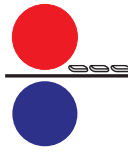

GR-500~ 6000 A

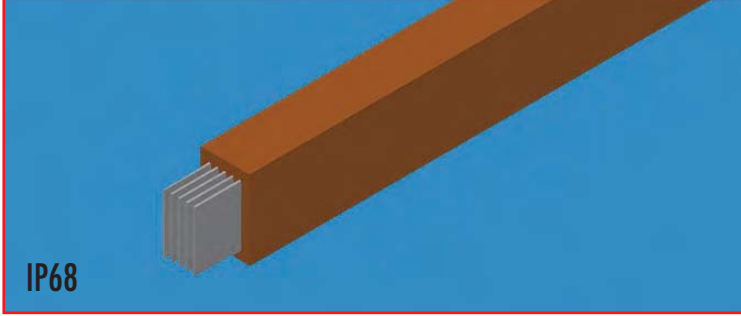

- * 500-6000 Amper aralığında üretilir.
- * İletkenler Kalay kaplıdır.
- * Tamamı reçineden imal edilmiş gövde ile nemli ve tuzlu ortamlar için geliştirilmiştir .
- * Kalın reçine izolasyon yapısı ile korozyona karşı daha iyi koruma sağlar.
- * Dönüş ve offset aksesuarları kaynaklıdır.
- * Ek noktası kısa devreye imkan vermez ve bolt-on çıkış olabilecek donanıma sahiptir.
- * Standart IP68 koruma sınıfında üretilir.
- * Busbar ile ilgili uluslararası tüm sertifikalara ve CE belgesine sahiptir.
- * *Production range is between 500-6000A.*
- * *Conductors are tin plated.*
- * *Designed for environmental factors such as humidity and saline environments with its entire cast resin housing.*
- * *Offers better protection against corrosion with its cast resin insulation structure.*
- * *The corners and off-set accessories are non-welded products.*
- * *Avoids short-cut and has equipment to get bolt-on point with improved joint technique.*
- * *Are manufactured with IP68 standard.*
- * *Owms all international certifications and CE certification about busbar systems.*

- * تنتج بفواصل 500-600 امبير .
- * المواصلات مكسوة بالقصدير
- * الهيكل مصنوعة من الرانتج كاملا ومصممة خصيصا للاوساط الرطبة والملحية .
- * توفر الحماية الجيدة ضد التاكسد فضلا على بنيتها الرانتجية السمكية المعزولة
- * تسابع العودة والافسيت غير ملحومة
- * تملك النقطة الاضافية على تجهيزات خروج تربياسي والتي تمنع حدوث الدورة القصيرة .
- * يتم انتاجها في فنة حماية اي بي 68 القياسية
- * تملك على كافة انواع الشهادات والوثائق الدولية المتعلقة عن البسبار .

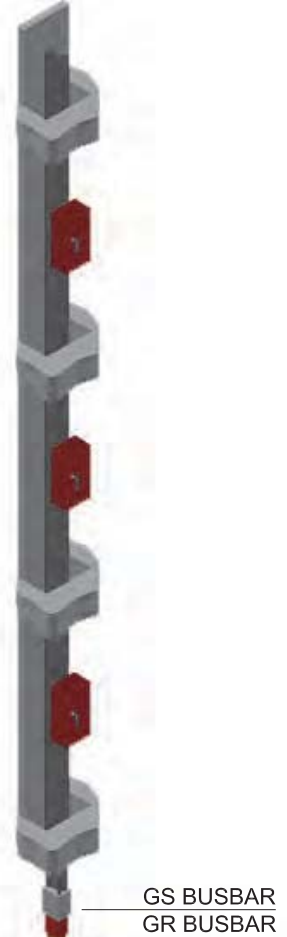

GR - O.G. ORTA GERİLİM
GR - M.V. MEDIUM VOLTAGE
ج - او. جي الجهد المتوسط

GR - A.G. ALÇAK GERİLİM
GR - L.V. LOW VOLTAGE
ج - او. جي الجهد المتوسط



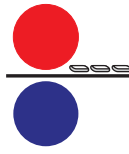

GR - CAST RESIN

GR-A
500A - 5000A

İletken olarak kullanılan malzeme alüminyumdur (EC Grade).
The conductors used in this serie are aluminium(EC Grade).
الموصلات المستخدمة في المجموعة من الألومنيوم (درجة EC)

GR-C
500A - 6000A

İletken olarak kullanılan malzeme elektrolitik bakırdır (%99.9 Safılıkta).
The conductors used in this serie are electrolytic copper(%99.9 purity).
الموصلات المستخدمة في المجموعة هي من النحاس العالي التوصيل
(%99.9 درجة النقاء)

3P / 3P+N / 3P+N+E / 3P+2N+E / 3P+N+2E

GR-A	GR-C	X mm
	GR-C 500A	170
GR-A 500A	GR-C 630A	170
GR-A 630A	GR-C 800A	170
GR-A 800A	GR-C 1000A	170
GR-A 1000A	GR-C 1250A	170
GR-A 1250A	GR-C 1600A	170
GR-A 1600A	GR-C 2000A	170
GR-A 2000A	GR-C 2500A	220
GR-A 2500A	GR-C 3200A	220

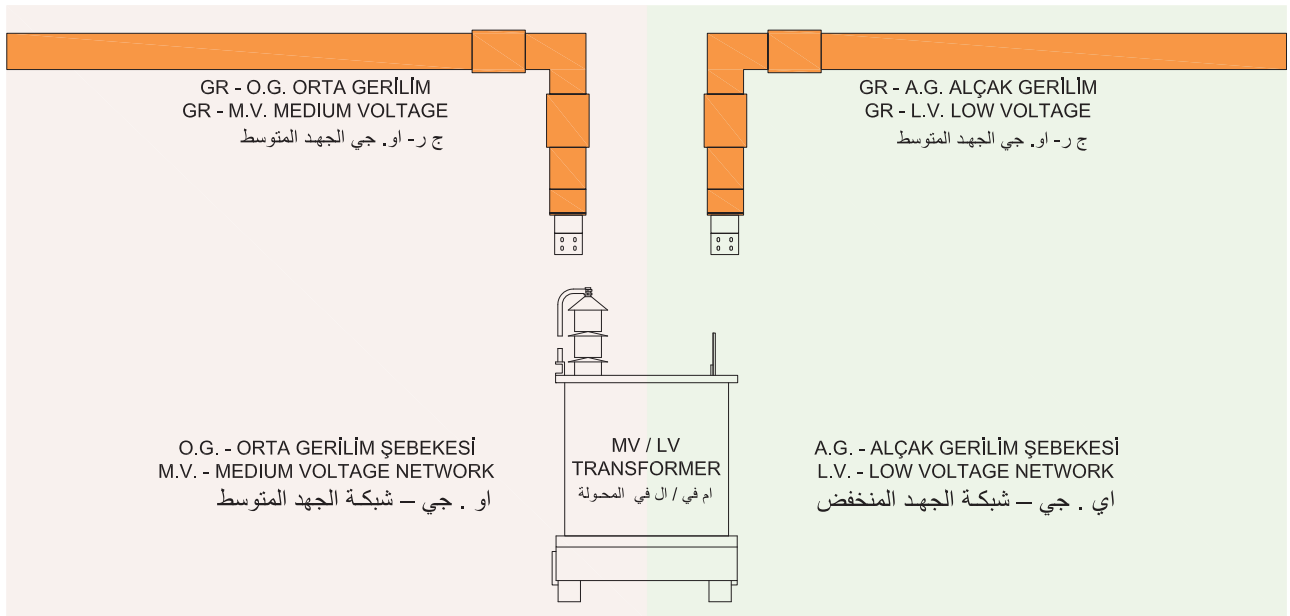
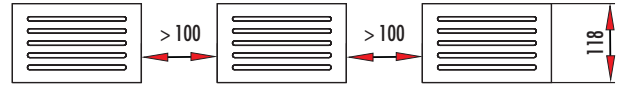
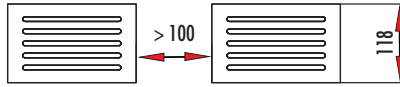
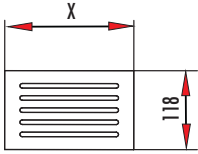

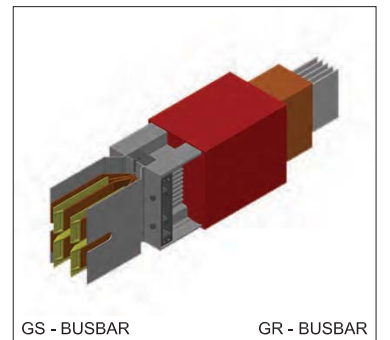
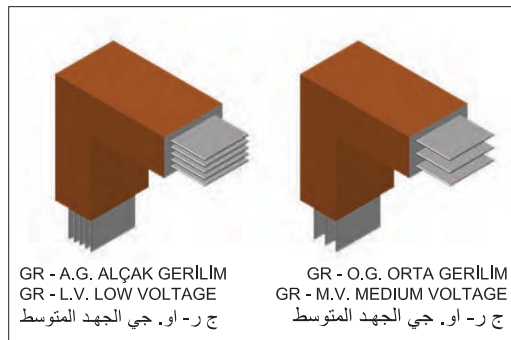
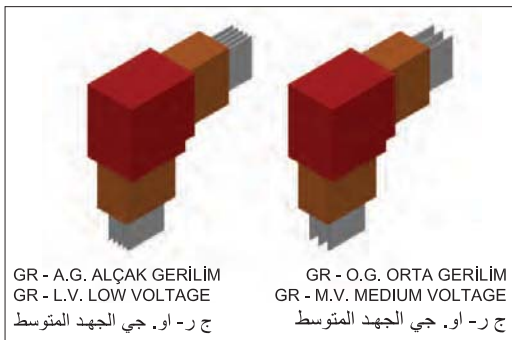
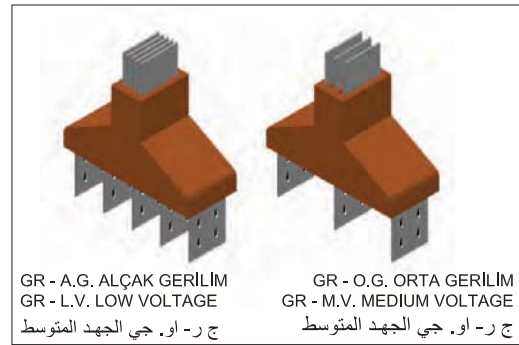
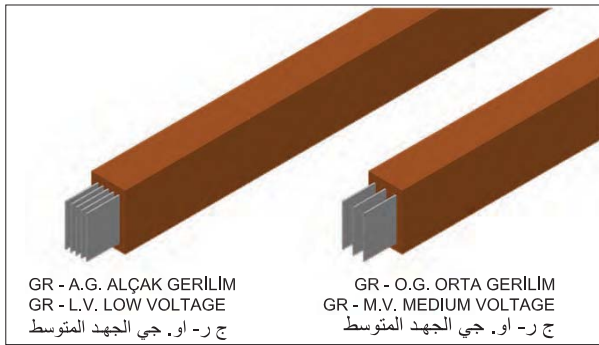
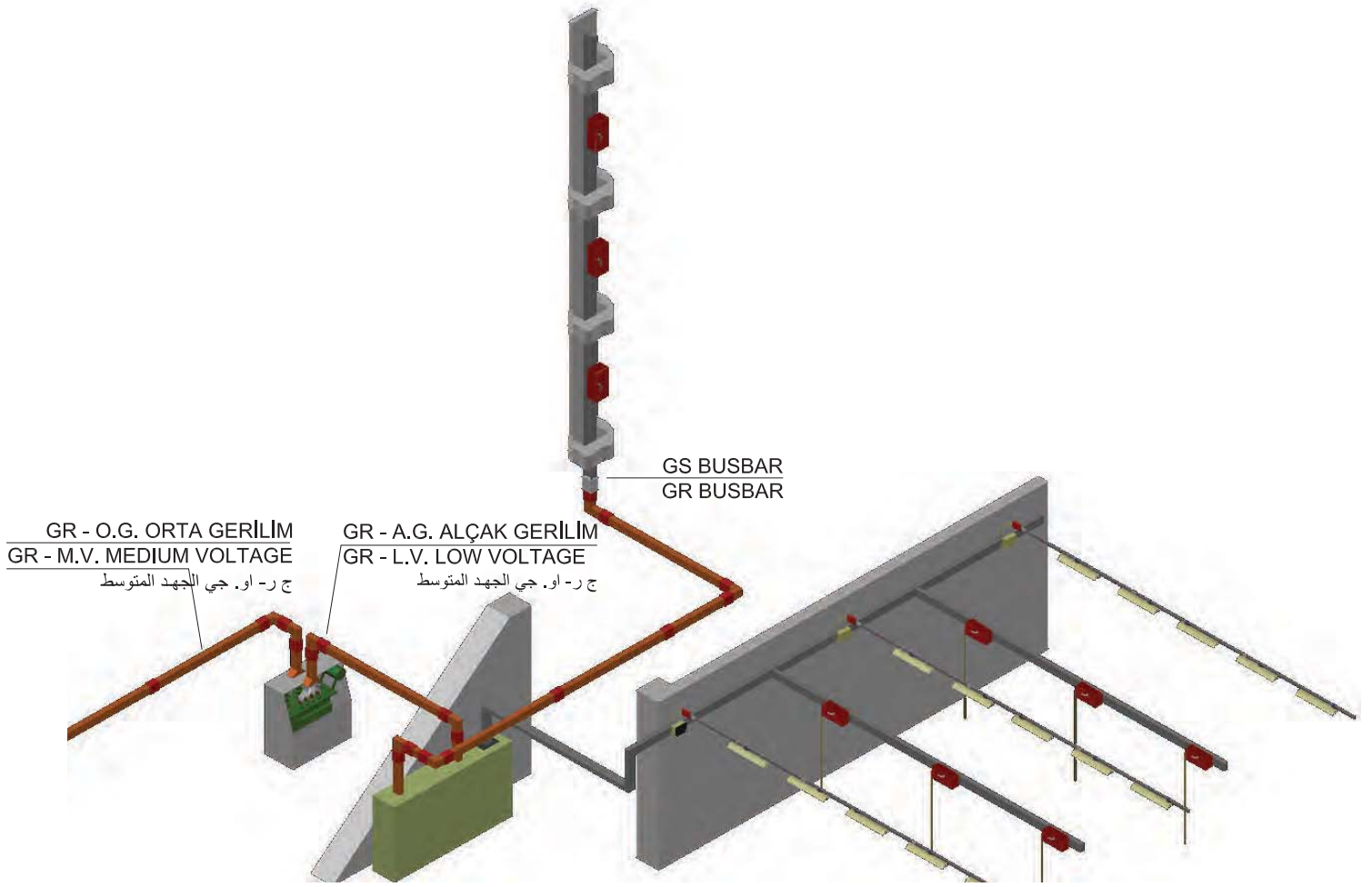
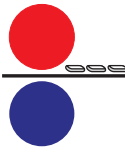



STANDART BOY ELEMAN (BOLT-ON) Standard Length Element (Bolt-on) (صامولة الربط) عنصر الطول القياسي

GR-A 3P			
Sipariş kodu Order code رمز الطلب	Stok kodu Stock code رمز المخزن	Amper A	Ağırlık (Kg/ad) Weight (Kg/unit) الوزن (كجم / الوحدة)
GR-A3 030105	850105005524030	500	124.680
GR-A3 030106	850106305524030	630	124.680
GR-A3 030108	850108005524030	800	124.680
GR-A3 030110	850110005524030	1000	124.680
GR-A3 030112	850112505524030	1250	124.680
GR-A3 030116	850116005524030	1600	122.910
GR-A3 030120	850120005524030	2000	157.830
GR-A3 030125	850125005524030	2500	157.830

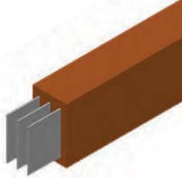

GR-A 3P+N+Pe			
Sipariş kodu Order code رمز الطلب	Stok kodu Stock code رمز المخزن	Amper A	Ağırlık (Kg/ad) Weight (Kg/unit) الوزن (كجم / الوحدة)
GR-A5 050105	850105005524050	500	147.850
GR-A5 050106	850106305524050	630	147.850
GR-A5 050108	850108005524050	800	147.850
GR-A5 050110	850110005524050	1000	147.850
GR-A5 050112	850112505524050	1250	147.850
GR-A5 050116	850116005524050	1600	150.340
GR-A5 050120	850120005524050	2000	196.040
GR-A5 030125	850125005524050	2500	196.040

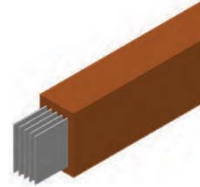

GR-C 3P			
Sipariş kodu Order code رمز الطلب	Stok kodu Stock code رمز المخزن	Amper A	Ağırlık (Kg/ad) Weight (Kg/unit) الوزن (كجم / الوحدة)
GR-C3 030105	860105005514031	500	131.690
GR-C3 030106	860106305514031	630	131.690
GR-C3 030108	860108005514031	800	131.690
GR-C3 030110	860110005514031	1000	131.690
GR-C3 030112	860112505514031	1250	131.690
GR-C3 030116	860116005514031	1600	131.690
GR-C3 030120	860120005514031	2000	131.230
GR-C3 030125	860125005514031	2500	169.380
GR-C3 030132	860132005524031	3200	169.380

GR-C 3P+N+Pe			
Sipariş kodu Order code رمز الطلب	Stok kodu Stock code رمز المخزن	Amper A	Ağırlık (Kg/ad) Weight (Kg/unit) الوزن (كجم / الوحدة)
GR-C5 050105	860105005514051	500	227.790
GR-C5 050106	860106305514051	630	227.790
GR-C5 050108	860108005514051	800	227.790
GR-C5 050110	860110005514051	1000	227.790
GR-C5 050112	860112505514051	1250	227.790
GR-C5 050116	860116005514051	1600	227.790
GR-C5 050120	860120005514051	2000	245.200
GR-C5 100125	860125005514051	2500	327.740
GR-C5 030132	860132005524051	3200	327.740

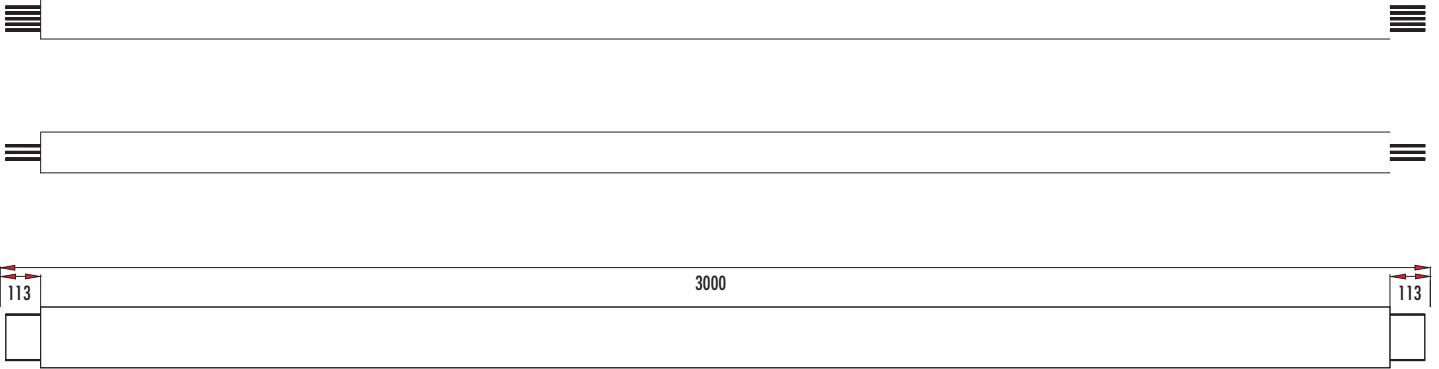



PANO - TRAFÖ ÜSTÜ ELEMANI Panel - Transformer Side Element

عنصر محول جانبي

GR-A 3P				
Sipariş kodu Order code رمز الطلب	Stok kodu Stock code رمز المخزن	Amper A	Ağırlık (Kg/ad) Weight (Kg/unit) الوزن (كجم / الوحدة)	
GR-A3 TS 05	850705005520030	500	21.770	
GR-A3 TS 06	850706305520030	630	21.770	
GR-A3 TS 08	850708005520030	800	21.770	
GR-A3 TS 10	850710005520030	1000	21.770	
GR-A3 TS 12	850712505520030	1250	21.770	
GR-A3 TS 16	850716005520030	1600	22.130	
GR-A3 TS 20	850720005520030	2000	28.850	
GR-A3 TS 25	850725005520030	2500	28.850	



GR-A 3P+N+Pe				
Sipariş kodu Order code رمز الطلب	Stok kodu Stock code رمز المخزن	Amper A	Ağırlık (Kg/ad) Weight (Kg/unit) الوزن (كجم / الوحدة)	
GR-A5 TS 05	850705005520050	500	22.980	
GR-A5 TS 06	850706305520050	630	22.980	
GR-A5 TS 08	850708005520050	800	22.980	
GR-A5 TS 10	850710005520050	1000	22.980	
GR-A5 TS 12	850712505520050	1250	22.980	
GR-A5 TS 16	850716005520050	1600	23.570	
GR-A5 TS 20	850720005520050	2000	30.830	
GR-A5 TS 25	850725005520050	2500	30.830	

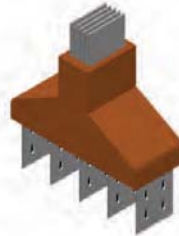

GR-C 3P				
Sipariş kodu Order code رمز الطلب	Stok kodu Stock code رمز المخزن	Amper A	Ağırlık (Kg/ad) Weight (Kg/unit) الوزن (كجم / الوحدة)	
GR-C3 TS 05	860705005510031	500	28.780	
GR-C3 TS 06	860706305510031	630	28.780	
GR-C3 TS 08	860708005510031	800	28.780	
GR-C3 TS 10	860710005510031	1000	28.780	
GR-C3 TS 12	860712505510031	1250	28.780	
GR-C3 TS 16	860716005510031	1600	28.780	
GR-C3 TS 20	860720005510031	2000	30.450	
GR-C3 TS 25	860725005510031	2500	40.400	
GR-C3 TS 32	860732005510031	3200	40.400	

GR-C 3P+N+Pe				
Sipariş kodu Order code رمز الطلب	Stok kodu Stock code رمز المخزن	Amper A	Ağırlık (Kg/ad) Weight (Kg/unit) الوزن (كجم / الوحدة)	
GR-C5 TS 05	860705005510051	500	34.400	
GR-C5 TS 06	860706305510051	630	34.400	
GR-C5 TS 08	860708005510051	800	34.400	
GR-C5 TS 10	860710005510051	1000	34.400	
GR-C5 TS 12	860712505510051	1250	34.400	
GR-C5 TS 16	860716005510051	1600	34.400	
GR-C5 TS 20	860720005510051	2000	37.140	
GR-C5 TS 25	860725005510051	2500	49.630	
GR-C5 TS 32	860732005520051	3200	49.630	

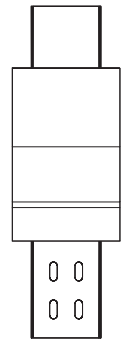
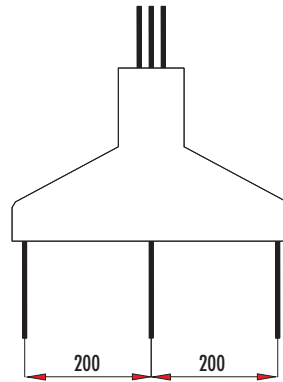
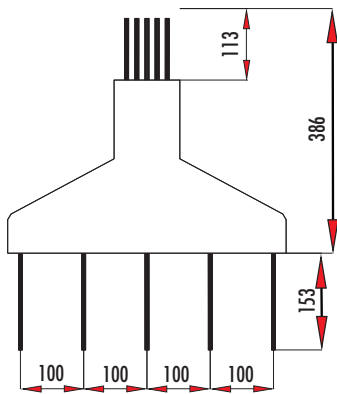

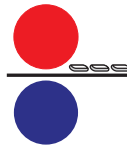

90° DİKEY DÖNÜŞ ELEMANI 90° Vertical Elbow Element عنصر كوع رأسي 90 درجة

GR-A 3P				
Sipariş kodu Order code رمز الطلب	Stok kodu Stock code رمز المخزن	Amper A	Ağırlık (Kg/ad) Weight (Kg/unit) الوزن (كجم/الوحدة)	
GR-A3 VE 05	853105005520030	500	11.920	
GR-A3 VE 06	853106305520030	630	11.920	
GR-A3 VE 08	853108005520030	800	11.920	
GR-A3 VE 10	853110005520030	1000	11.920	
GR-A3 VE 12	853112505520030	1250	11.920	
GR-A3 VE 16	853116005520030	1600	12.190	
GR-A3 VE 20	853120005520030	2000	17.970	
GR-A3 VE 25	853125005520030	2500	17.970	

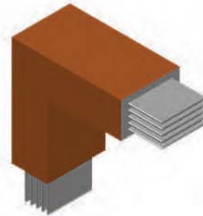
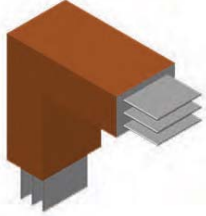

GR-A 3P+N+Pe				
Sipariş kodu Order code رمز الطلب	Stok kodu Stock code رمز المخزن	Amper A	Ağırlık (Kg/ad) Weight (Kg/unit) الوزن (كجم/الوحدة)	
GR-A5 VE 05	853105005520050	500	12.970	
GR-A5 VE 06	853106305520050	630	12.970	
GR-A5 VE 08	853108005520050	800	12.970	
GR-A5 VE 10	853110005520050	1000	12.970	
GR-A5 VE 12	853112505520050	1250	12.970	
GR-A5 VE 16	853116005520050	1600	13.430	
GR-A5 VE 20	853120005520050	2000	20.450	
GR-A5 VE 25	853125005520050	2500	20.450	

GR-C 3P				
Sipariş kodu Order code رمز الطلب	Stok kodu Stock code رمز المخزن	Amper A	Ağırlık (Kg/ad) Weight (Kg/unit) الوزن (كجم/الوحدة)	
GR-C3 VE 05	863105005510031	500	17.790	
GR-C3 VE 06	863106305510031	630	17.790	
GR-C3 VE 08	863108005510031	800	17.790	
GR-C3 VE 10	863110005510031	1000	17.790	
GR-C3 VE 12	863112505510031	1250	17.790	
GR-C3 VE 16	863116005510031	1600	17.790	
GR-C3 VE 20	863120005510031	2000	19.130	
GR-C3 VE 25	863125005510031	2500	28.410	
GR-C3 VE 32	863132005510031	3200	28.410	

GR-C 3P+N+Pe				
Sipariş kodu Order code رمز الطلب	Stok kodu Stock code رمز المخزن	Amper A	Ağırlık (Kg/ad) Weight (Kg/unit) الوزن (كجم/الوحدة)	
GR-C5 VE 05	863105005510051	500	22.790	
GR-C5 VE 06	863106305510051	630	22.790	
GR-C5 VE 08	863108005510051	800	22.790	
GR-C5 VE 10	863110005510051	1000	22.790	
GR-C5 VE 12	863112505510051	1250	22.790	
GR-C5 VE 16	863116005510051	1600	22.790	
GR-C5 VE 20	863120005510051	2000	25.010	
GR-C5 VE 25	863125005510051	2500	36.550	
GR-C5 VE 32	863132005510051	3200	36.550	

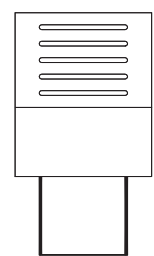
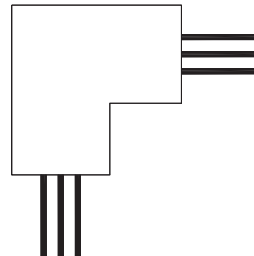
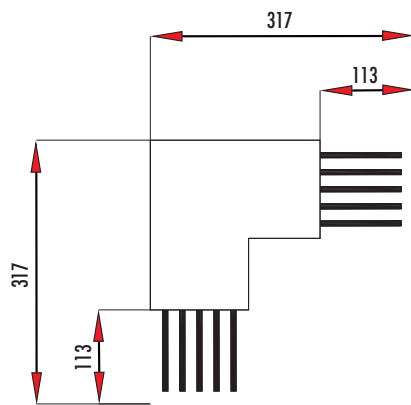

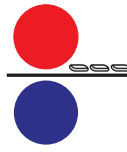

90° YATAY DÖNÜŞ ELEMANI 90° Horizontal Elbow Element عنصر كوع أفقي 90 درجة

GR-A 3P

Sipariş kodu Order code رمز الطلب	Stok kodu Stock code رمز المخزن	Amper A	X mm	Y mm	Ağırlık (Kg/ad) Weight (Kg/unit) الوزن (كجم/الوحدة)
GR-A3 HE 05	852905005520030	500	402	402	16.320
GR-A3 HE 06	852906305520030	630	402	402	16.320
GR-A3 HE 08	852908005520030	800	402	402	16.320
GR-A3 HE 10	852910005520030	1000	402	402	16.320
GR-A3 HE 12	852912505520030	1250	402	402	16.320
GR-A3 HE 16	852916005520030	1600	402	402	12.930
GR-A3 HE 20	852920005520030	2000	427	427	18.100
GR-A3 HE 25	852925005520030	2500	427	427	18.100

GR-A 3P+N+Pe

Sipariş kodu Order code رمز الطلب	Stok kodu Stock code رمز المخزن	Amper A	X mm	Y mm	Ağırlık (Kg/ad) Weight (Kg/unit) الوزن (كجم/الوحدة)
GR-A5 HE 05	852905005520050	500	402	402	17.490
GR-A5 HE 06	852906305520050	630	402	402	17.490
GR-A5 HE 08	852908005520050	800	402	402	17.490
GR-A5 HE 10	852910005520050	1000	402	402	17.490
GR-A5 HE 12	852912505520050	1250	402	402	17.490
GR-A5 HE 16	852916005520050	1600	402	402	18.040
GR-A5 HE 20	852920005520050	2000	427	427	21.980
GR-A5 HE 25	852925005520050	2500	427	427	21.980

GR-C 3P

GR-C3 HE 05	862905005510031	500	402	402	23.630
GR-C3 HE 06	862906305510031	630	402	402	23.630
GR-C3 HE 08	862908005510031	800	402	402	23.630
GR-C3 HE 10	862910005510031	1000	402	402	23.630
GR-C3 HE 12	862912505510031	1250	402	402	23.630
GR-C3 HE 16	862916005510031	1600	402	402	23.630
GR-C3 HE 20	862920005510031	2000	402	402	25.270
GR-C3 HE 25	862925005510031	2500	427	427	31.010
GR-C3 HE 32	862932005510031	3200	427	427	31.010

GR-C 3P+N+Pe

GR-C5 HE 05	862905005510051	500	402	402	29.640
GR-C5 HE 06	862906305510051	630	402	402	29.640
GR-C5 HE 08	862908005510051	800	402	402	29.640
GR-C5 HE 10	862910005510051	1000	402	402	29.640
GR-C5 HE 12	862912505510051	1250	402	402	29.640
GR-C5 HE 16	862916005510051	1600	402	402	29.640
GR-C5 HE 20	862920005510051	2000	402	402	32.430
GR-C5 HE 25	862925005510051	2500	427	427	39.860
GR-C5 HE 32	862932005510051	3200	427	427	39.860

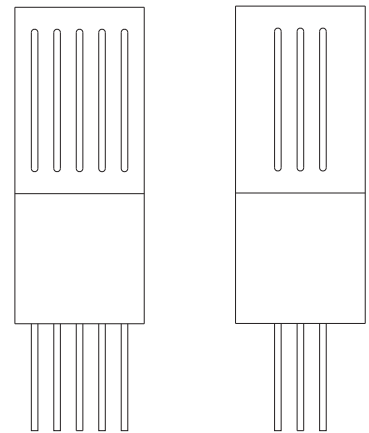
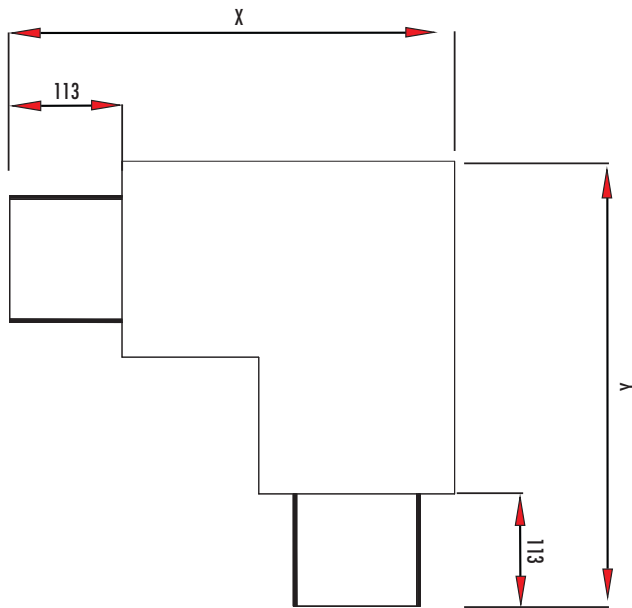

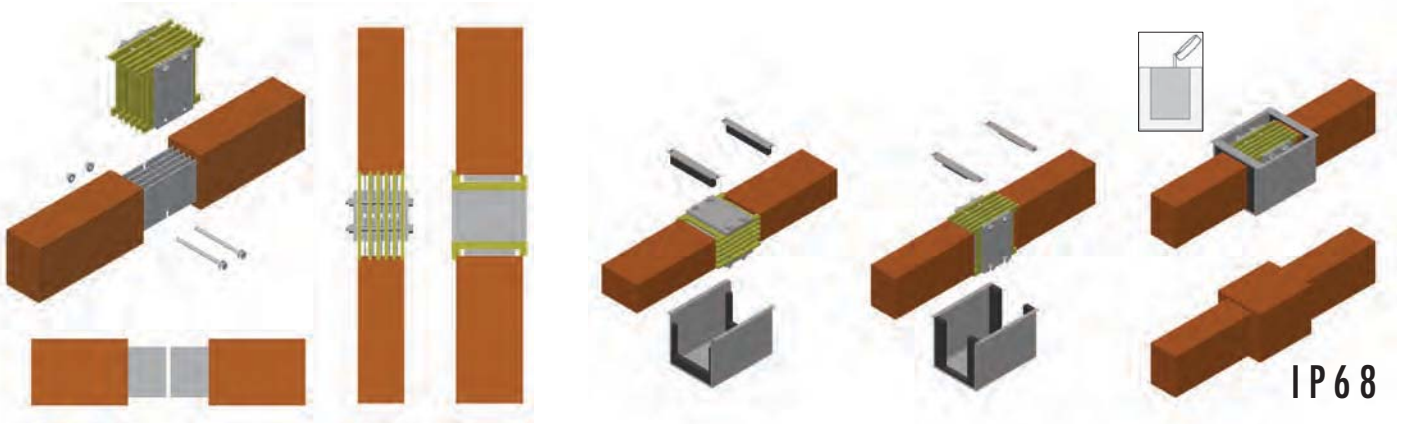
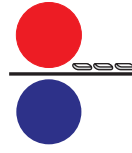

IP68

GRA - TEKNİK BİLGİLER

GRA - Technical Details

التفاصيل الفنية لـ GRA

		500A	630A	800A	1000A	1250A	1600A	2000A	2500A	
		500	630	800	1000	1250	1600	2000	2500	A
İzolasyon Gerilim جهد العزل	Insulation Voltage U _i	36								kV
Faz/Nötr/Toprak Kesiti Cross Section of Phase/Neutral/Earth	Sf	660	660	660	660	660	780	1080	1080	mm ²
Faz Kısa Devre Akımı (1sn) Short-Circuit Current of Phases (1s) تيار توصيل الفازات (1 ثانية)	I _{cw}	50	50	50	50	50	50	50	50	kA
Faz Pik Akımı Peak Current of Phases قمة تيار الفازات	I _{pk}	110	110	110	110	110	110	110	110	kA
Faz Direnci Phase Resistance مقاومة الفاز	R ₁	0,062	0,062	0,062	0,062	0,062	0,038	0,029	0,029	mΩ/m
Faz Reaktansı Phase Reactance مفاعلة الفاز	X ₁	0,015	0,015	0,015	0,015	0,015	0,030	0,014	0,014	mΩ/m
Faz Empedansı Phase Impedance مقاومة الفاز	Z ₁	0,064	0,064	0,064	0,064	0,064	0,048	0,032	0,032	mΩ/m
Dağınmık Yükte Gerilim Düşümü Tablosu [ΔV] Voltage drop with distributed load الهبوط في الجهد في لوحة التوزيع Cosφ : 0,95-α:0,5	[mV/m]	500A [A] 27,096	630A [A] 34,141	800A [A] 43,354	1000A [A] 54,192	1250A [A] 67,740	1600A [A] 80,342	2000A [A] 93,717	2500A [A] 107,000	

GRC - TEKNİK BİLGİLER

GRC - Technical Details

التفاصيل الفنية لـ GRC

		500A	630A	800A	1000A	1250A	1600A	2000A	2500A	3200A
		500	630	800	1000	1250	1600	2000	2500	3200
İzolasyon Gerilim جهد العزل	U _i	36								kV
Faz/Nötr/Toprak Kesiti Cross Section of Phase/Neutral/Earth	Sf	660	660	660	660	660	660	780	1080	1080
Faz Kısa Devre Akımı (1sn) Short-Circuit Current of Phases (1s) تيار توصيل الفازات (1 ثانية)	I _{cw}	50	50	50	50	50	50	50	50	50
Faz Pik Akımı Peak Current of Phases قمة تيار الفازات	I _{pk}	110	110	110	110	110	110	110	110	110
Faz Direnci Phase Resistance مقاومة الفاز	R ₁	0,038	0,038	0,038	0,038	0,038	0,038	0,023	0,022	0,022
Faz Reaktansı Phase Reactance مفاعلة الفاز	X ₁	0,014	0,014	0,014	0,014	0,014	0,014	0,013	0,013	0,013
Faz Empedansı Phase Impedance مقاومة الفاز	Z ₁	0,041	0,041	0,041	0,041	0,041	0,041	0,026	0,026	0,026
Dağınmık Yükte Gerilim Düşümü Tablosu [ΔV] Voltage drop with distributed load الهبوط في الجهد في لوحة التوزيع Cosφ : 0,95-α:0,5	[mV/m]	500A [A] 17,127	630A [A] 21,580	800A [A] 27,403	1000A [A] 34,254	1250A [A] 42,818	1600A [A] 54,806	2000A [A] 68,423	2500A [A] 85,524	3200A [A] 109,000